

Panasonic

Voice Processing System

Subscriber's Guide

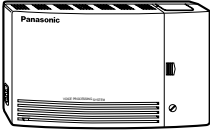

Model No. **KX-TVS50/KX-TVS80**



Please read before using and save this manual for future use.

Introduction

Thank you for purchasing the Panasonic Model
KX-TVS50/80 Voice Processing System.

The Panasonic Voice Processing System (VPS) is a powerful tool used to manage your voice communications and increase your productivity through the use of your voice mailbox. As a subscriber (the owner of a VPS mailbox), you can:

- Send a message to one or more people inside or outside of your office.
- Transfer messages (with your annotation) to other VPS subscribers.
- Receive messages from any touch-tone telephone.
- Be called at an outside telephone or be notified through your beeper, when there are messages stored in your mailbox.
- Be notified by the message-waiting lamp on your extension that there are messages stored in your mailbox.
- Screen your calls.
- Automate the handling of callers.
- And more...

Getting Started

Numbers to Know

You must have the following information before you begin:

- The extension number(s) of the VPS.
- Your mailbox and extension number.
- The System Manager's phone number.

Basic Steps

When using your mailbox for the first time, you must read "Section 1: Mailbox Setup" and perform the key setup procedures described. You must customize your mailbox before sending or receiving messages.

Identify yourself as the owner of your mailbox by setting the following:

- Recording Personal Greetings
- Recording Your Name
- Setting Your Password



- This symbol identifies important notes about the operation being described.
- The voice prompt will guide you in every step of programming.

Structure of the Manual

This manual consists of the following sections:

Section 1 Mailbox Setup

Describes the procedures for customizing your mailbox.

Section 2 Receiving Messages

Explains how to access and manage received messages.

Section 3 Sending Messages

Tells you how to send messages, including recording and delivery.

Section 4 Special Features

Describes how to set up the special features for your mailbox.

Appendix

Glossary

Table of Contents

Section 1 Mailbox Setup	5
1.1 Logging into Your Mailbox	5
1.2 Recording Personal Greetings	6
1.3 Setting, Changing and Clearing Your Password	7
1.4 Recording Your Name	8
1.5 Service Access Commands	8
Section 2 Receiving Messages	9
2.1 Receiving Messages	9
2.2 Replying to Messages	10
2.3 Message Transfer	11
2.4 Accessing Your Mailbox from an Outside Telephone	12
Section 3 Sending Messages	13
3.1 Delivering Messages to Other Subscribers	13
3.2 Checking Mailbox Distribution	15
3.3 Setting up an External Message Delivery List	16
3.4 Sending External Delivery Messages	17
3.5 Receiving External Delivery Messages	18
3.6 Replying to External Delivery Messages	18
3.7 Checking and Setting External Message Delivery Status	19
Section 4 Special Features	20
4.1 Call Transfer Status	20
4.2 Covering Extension	20
4.3 Incomplete Call Handling Status	21
4.4 Message Reception Mode	21
4.5 Personal Group Distribution Lists	22
4.6 Deleting Group Distribution Members	22
4.7 Deleting Group Distribution List Names	23
4.8 Message Waiting Notification	23
4.9 Interview Mailbox	25
4.10 Recording Personal Greetings for Caller ID	26
4.11 Assigning Caller ID Numbers for Personal Greeting for Caller ID	27
4.12 Personal Caller Name Announcement	28
4.13 Live Call Screening	30
4.14 Recording a Two-Way Conversation	30
Appendix	31
Quick Reference	31
Glossary	32

Logging into Your Mailbox 1.1

Before you access Subscriber Services, you must first open your mailbox.

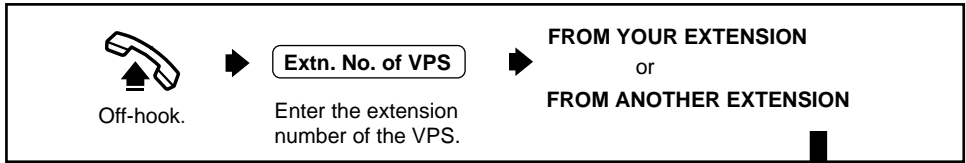

FROM YOUR EXTENSION (When the Direct Mailbox Access is enabled)

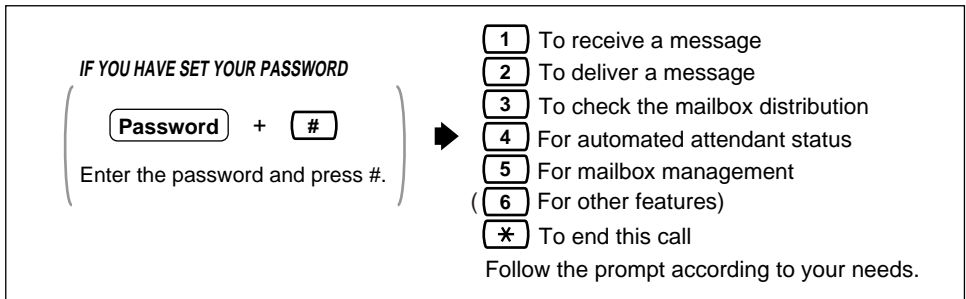

FROM ANOTHER EXTENSION

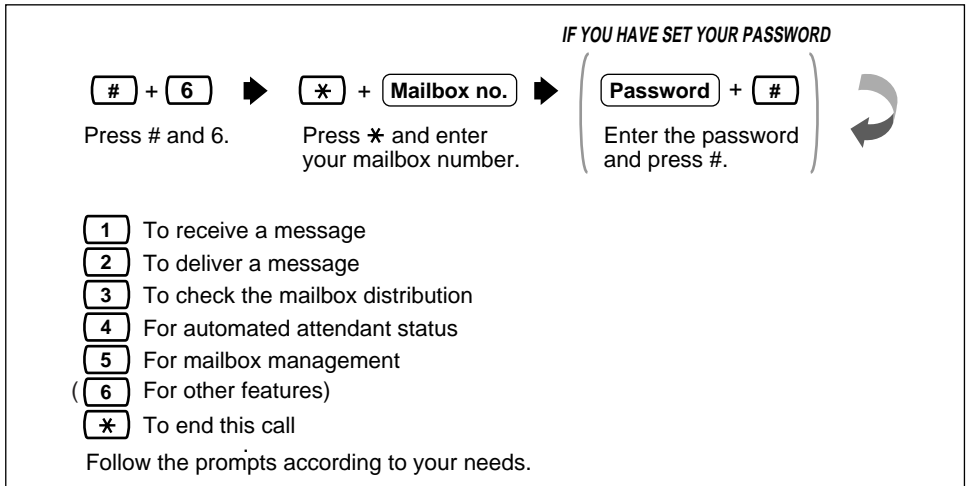

- “**6** For other features” can be heard only when the System Administrator or the System Manager assigns an Interview Mailbox to your mailbox, or authorizes the Message Waiting Notification feature or the External Message Delivery feature to you.
- If you do not know the VPS extension number, ask the System Manager.

1.2 Recording Personal Greetings

After reaching your mailbox, callers will hear your personal greeting message(s). You can record 3 kinds of personal greetings: No Answer Greeting, Busy Greeting, and After Hours Greeting.

The VPS plays the appropriate message for each call.

Personal greeting messages are always followed by a tone and a chance to leave a message. Your personal greeting should tell callers to “please leave a message at the tone” — otherwise your callers will be confused.

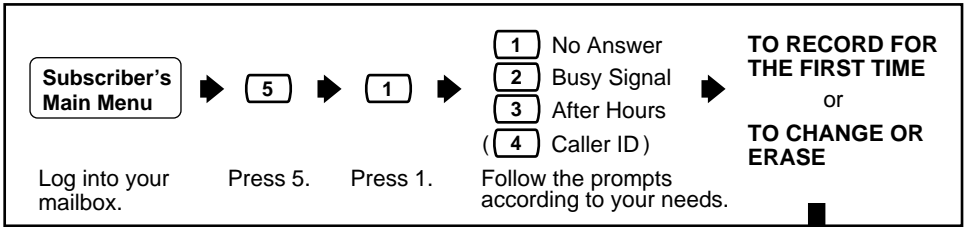

TO RECORD FOR THE FIRST TIME

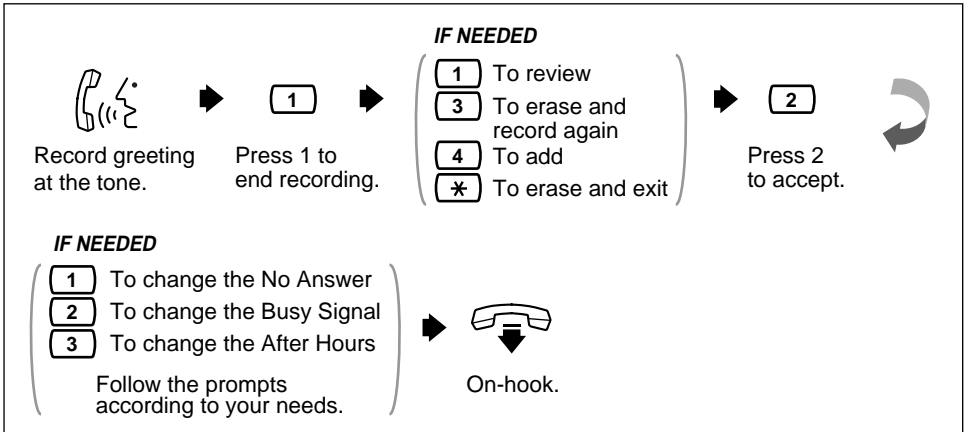

TO CHANGE OR ERASE

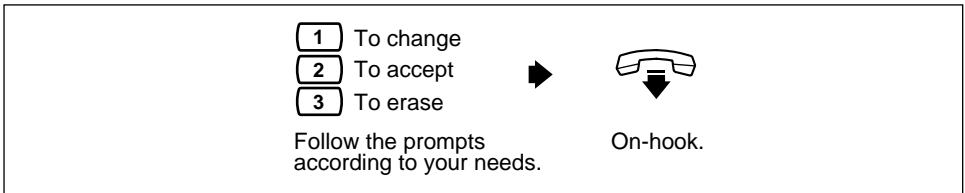

Recording Personal Greetings (contd.) 1.2



- Recording a Caller ID Greeting is available only when your COS parameter is enabled. To record a Caller ID Greeting, see 4.10 Recording Personal Greetings for Caller ID.
- Be sure to exit from the menu AFTER the greeting is accepted. Otherwise the greeting will not be stored.
- By system default, the maximum length of a personal greeting is 16 s. If you need more time, ask your System Administrator or System Manager to increase the upper bound.
- If you change the greeting, follow the steps in “TO RECORD FOR THE FIRST TIME” to re-record.
- It is recommended that you mention your name in each personal greeting, because the regular announcement of name (see 1.4 Recording Your Name) will be suppressed.

Setting, Changing and Clearing Your Password 1.3

The VPS provides the option of assigning a password to your mailbox to protect the messages stored there from unauthorized access. A password should be no longer than 8 digits (using the keys 0–9). You can change your password at any time. When setting your password, avoid using obvious number combinations. If you forget your password, have your System Administrator or System Manager clear it. You may then set a new one.

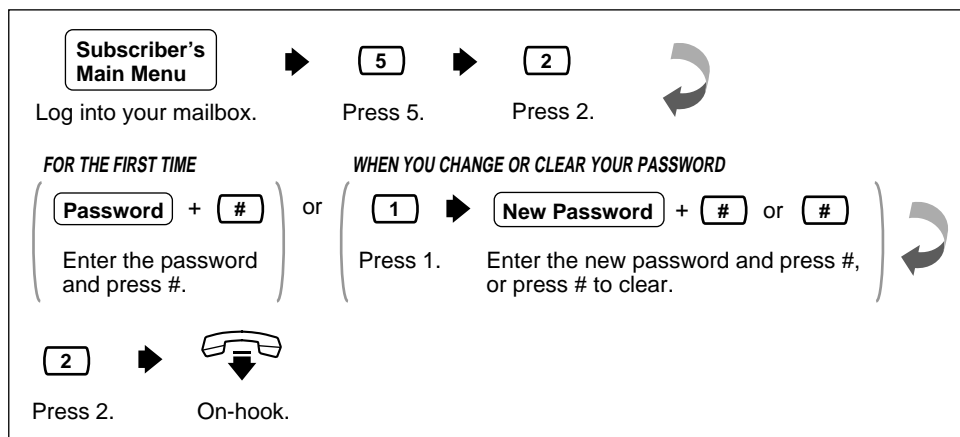

1.4 Recording Your Name

This recording informs callers that they have reached the correct mailbox (for example, when transferring a message to a subscriber, they will hear the subscriber's name). In addition, if a caller does not know the mailbox number and specifies the mailbox by entering the first 3 or 4 letters of the owner's name, the VPS will announce a series of recorded names which the caller may select.

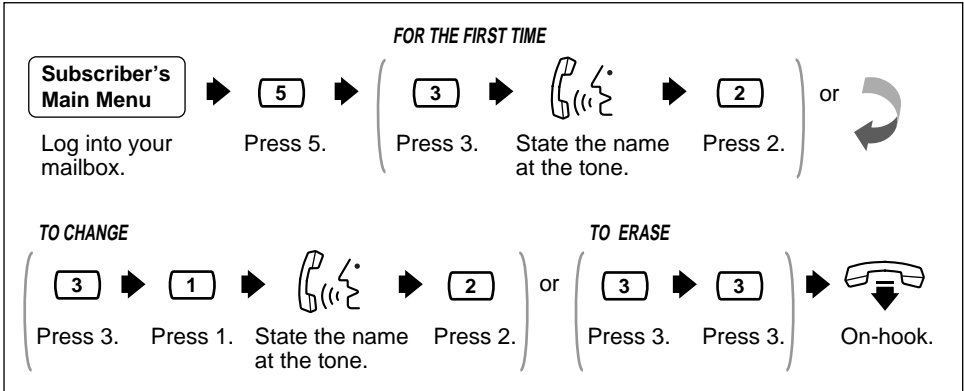

1.5 Service Access Commands

Before routinely using the VPS, you should familiarize yourself with the Service Access Commands shown in the Appendix.

The most important ones are the following:

- #6 – pressing this during system prompts activates Voice Mail Service. It prompts you for a mailbox number and then you can record a message. You can also press * and then your own mailbox number. In this case, you can log into your mailbox.
- #8 – pressing this during system prompts activates Automated Attendant Service. It prompts you for an extension number and then attempts to call your party. If he or she cannot take the call, the VPS will take some suitable action.
Note: If you call the extension directly, the VPS cannot help you.
- * – pressing this during system prompts takes you to the previous VPS menu. If you have lost bearings within Subscriber Service, use this command to get you out.
- 0 – pressing this lets you listen to the whole menu (for Help).

Receiving Messages 2.1

The VPS plays both the new and saved messages that are in your mailbox along with the date, time, and sender information pertaining to each message.

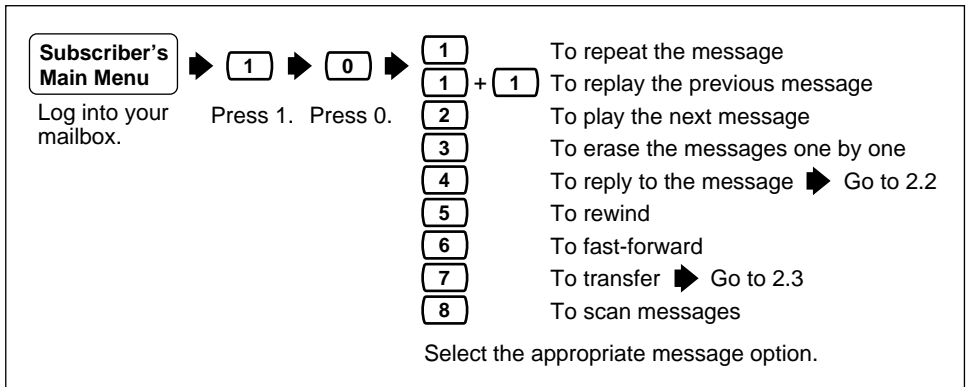

- **When all messages are scanned, you will have 3 options**

- 1** To replay the previous message
- 2** To play the next message
- 3** To play the entire message

Option 3 : "To play the entire message" is only available once. Selecting this option a second time will erase the message.

- The VPS will automatically erase messages after a specified number of days. Your System Administrator or System Manager controls the number of days messages will be maintained.

2.2 Replying to Messages

This feature allows you to reply to messages that have been sent by other subscribers through their mailboxes.



- You can reply only to messages that were transferred to you, or originated as “Delivering Message to Other Subscribers”.

TO RECORD A MESSAGE

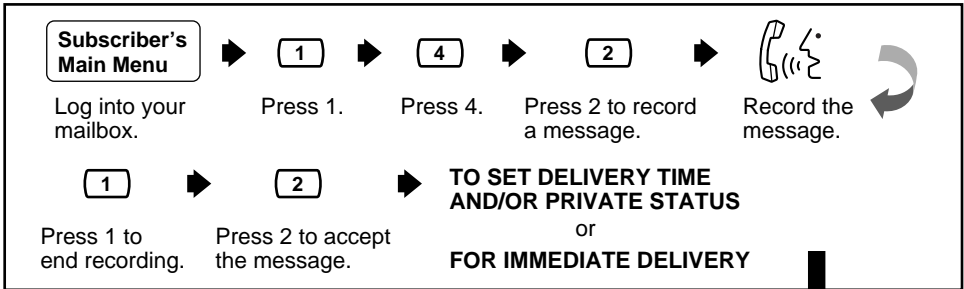

TO SET DELIVERY TIME AND/OR PRIVATE STATUS

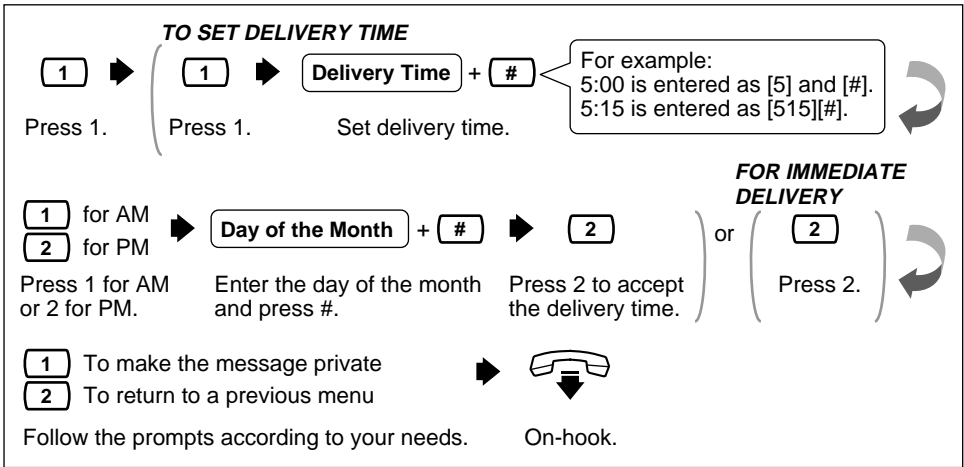

FOR IMMEDIATE DELIVERY



- If paused, the recording must be restarted within 20 s or the VPS will stop recording automatically.

This function allows you to transfer messages to other mailboxes.



- If the message is assigned as private, it cannot be transferred to other mailboxes.

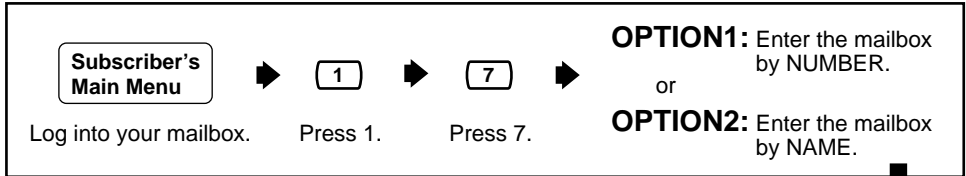

- You can also specify a Personal or a System Group Distribution List instead of an individual mailbox by entering the number of the list. If you use a Personal Group Distribution List, press [#] after the list number. Personal Group Distribution Lists must be created before they can be used. (See 4.5 Personal Group Distribution Lists.) To use a System Group Distribution List, check with the System Administrator to ensure that a list exists within the VPS.

OPTION1 : Enter the mailbox by NUMBER

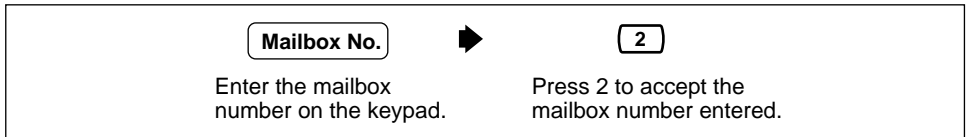

OPTION2 : Enter the mailbox by NAME

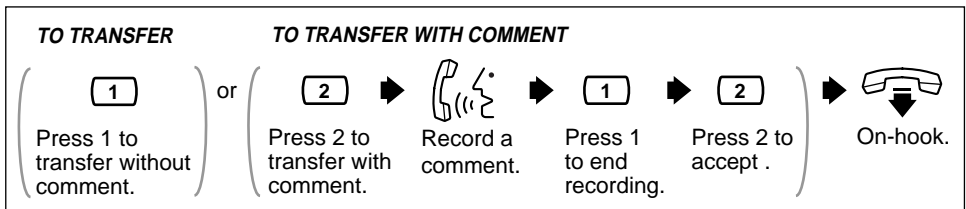
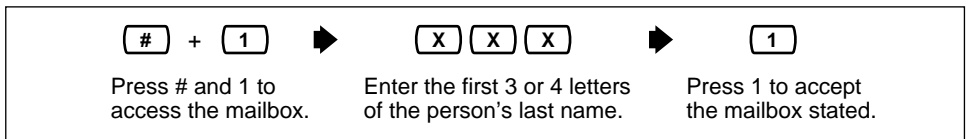

- No acknowledgement will be given that the message has been transferred.

2.4 Accessing Your Mailbox from an Outside Telephone

This procedure is used when checking your messages remotely.

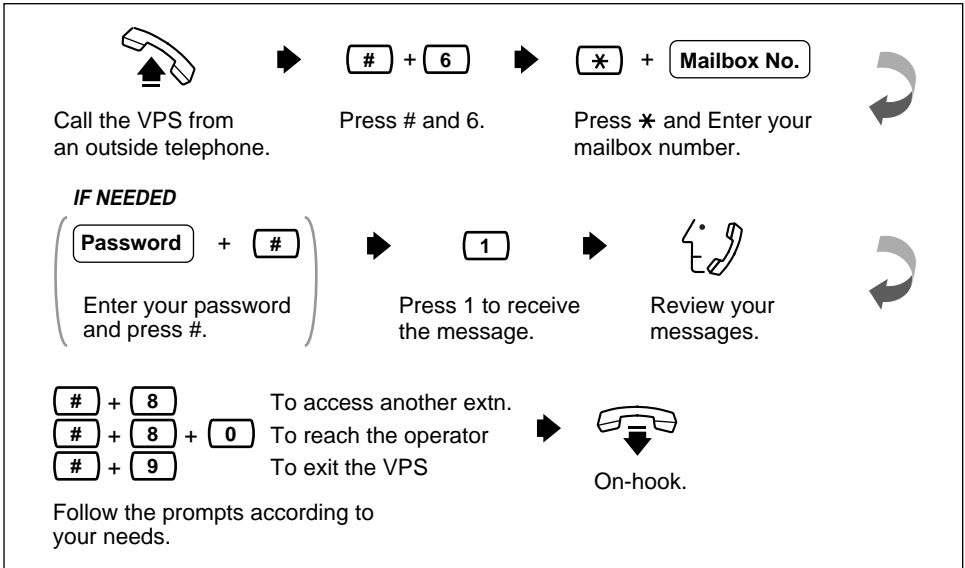

Delivering Messages to Other Subscribers 3.1

This feature is used when sending the same message to several subscribers.

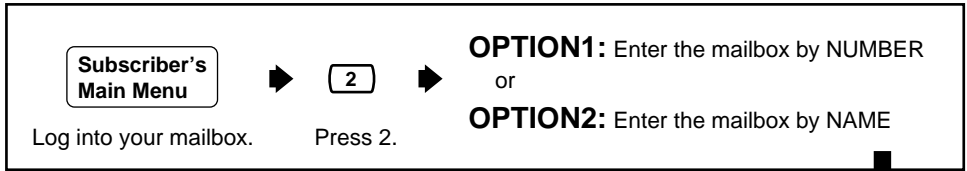

- You can also specify a Personal or a System Group Distribution List instead of an individual mailbox by entering the number of the list. If you use a Personal Group Distribution List, press [#] after the list number. Personal Group Distribution Lists must be created before they can be used. (See 4.5 Personal Group Distribution Lists.) To use a System Group Distribution List, check with the System Administrator to ensure that a list exists within the VPS.

OPTION1 : Enter the mailbox by NUMBER

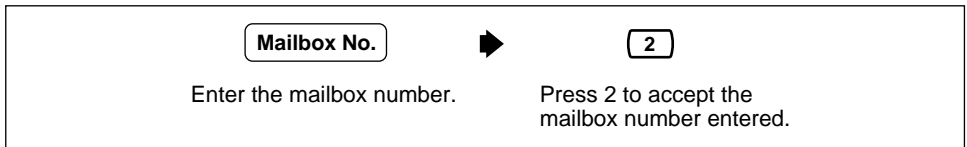

OPTION2 : Enter the mailbox by NAME

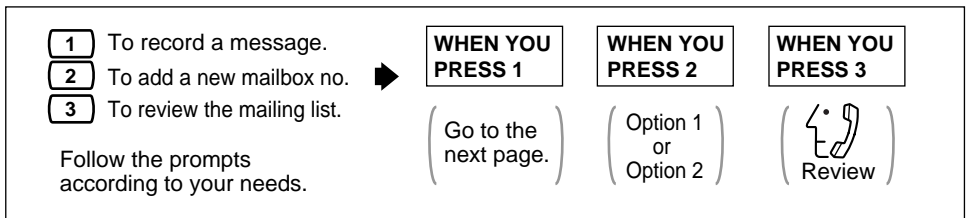
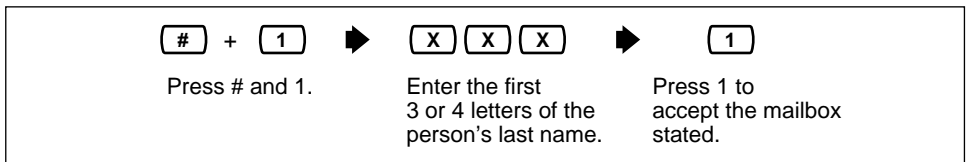

- You can specify a maximum of 20 mailboxes as destinations for 1 message.

3.1 Delivering Messages to Other Subscribers (contd.)

TO RECORD A MESSAGE

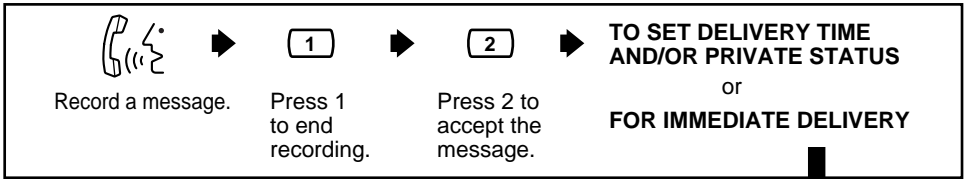

TO SET DELIVERY TIME AND/OR PRIVATE STATUS

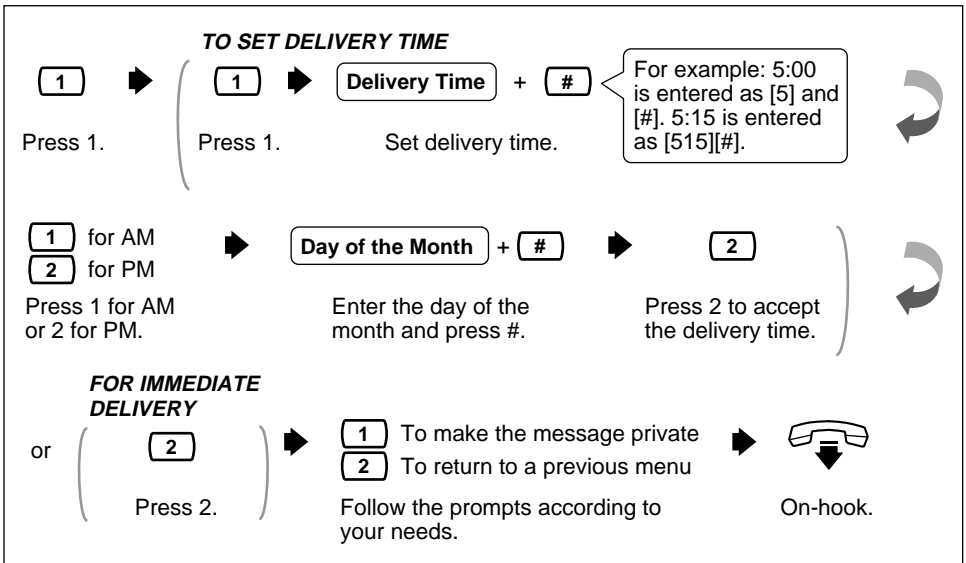

FOR IMMEDIATE DELIVERY

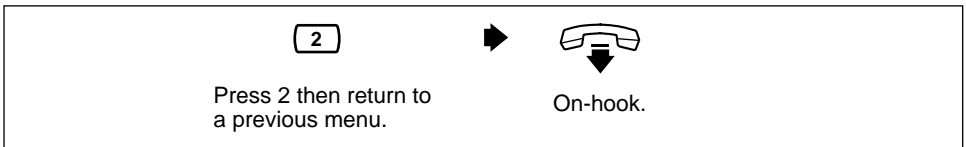

- If paused, the recording must be restarted within 20 s or the VPS will stop recording automatically.

Checking Mailbox Distribution 3.2

This function allows you to check the status of messages, which you have recorded in your mailbox, for delivery to other mailboxes.



- You can check the delivery status of up to 84 message transmissions.

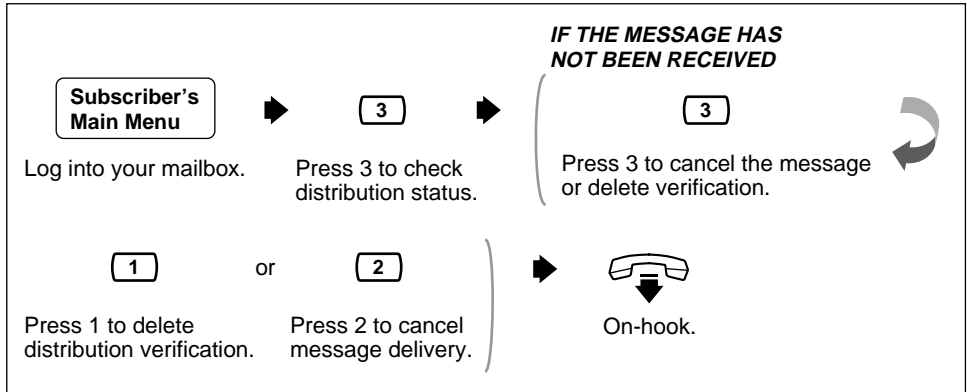

3.3 Setting up an External Message Delivery List

Setting up an External Message Delivery List lets you send the same message to several outside parties and/or extensions with a single operation. Up to 2 lists can be maintained at the same time, and each list can contain up to 8 members.

!! • The System Administrator or the System Manager must authorize this feature before it can be used.

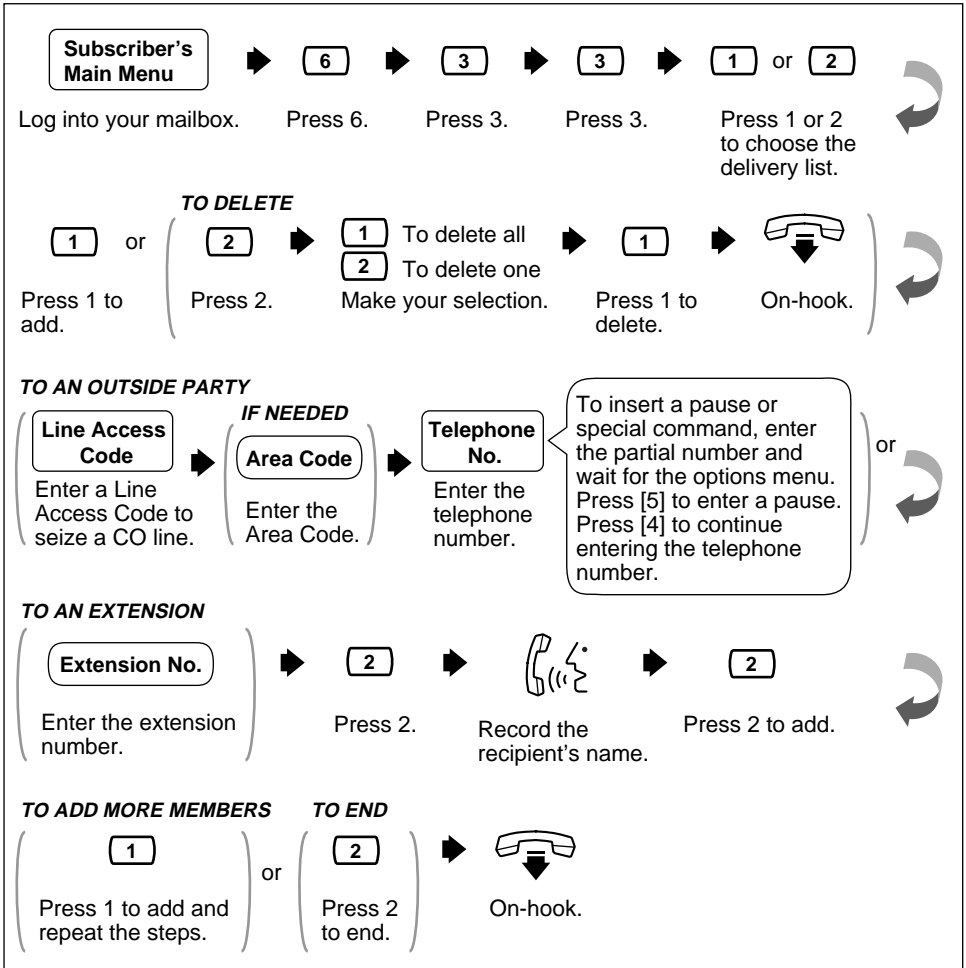

Sending External Delivery Messages 3.4

This feature is used to record and send external delivery messages.



- The System Administrator or the System Manager must authorize this feature before it can be used.

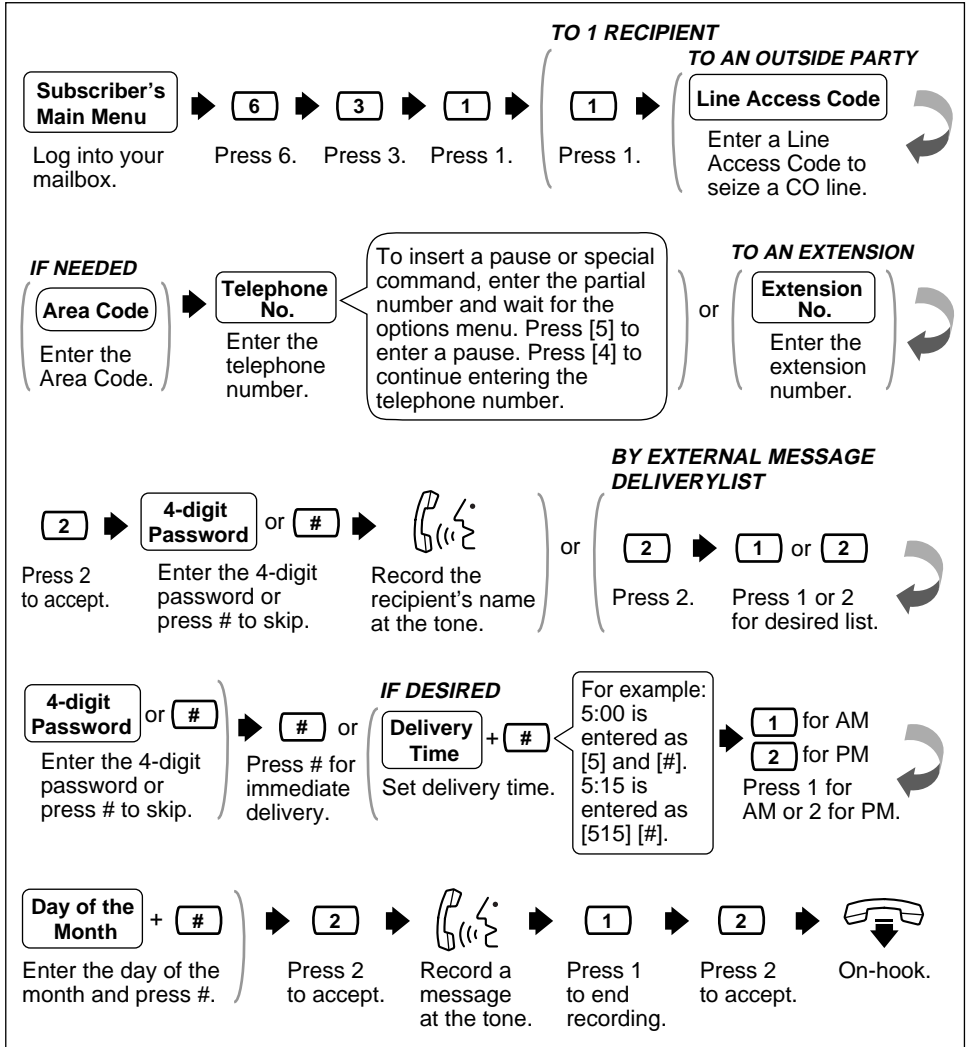

- The 4-digit password is not your password to log into your mailbox. You can decide it freely each time you send an external delivery message. Be sure to share the 4-digit password with the message receiver.

3.5 Receiving External Delivery Messages

This feature is used to receive External Delivery Messages.

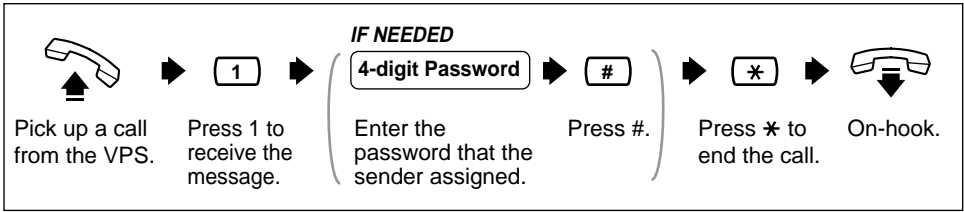

- Receiving the message will be disabled if an incorrect password is entered 3 times — however, if registered in the VPS, the Callback Telephone Number and the sender's extension number will be played.

3.6 Replying to External Delivery Messages

This feature is used to reply to External Delivery Messages.

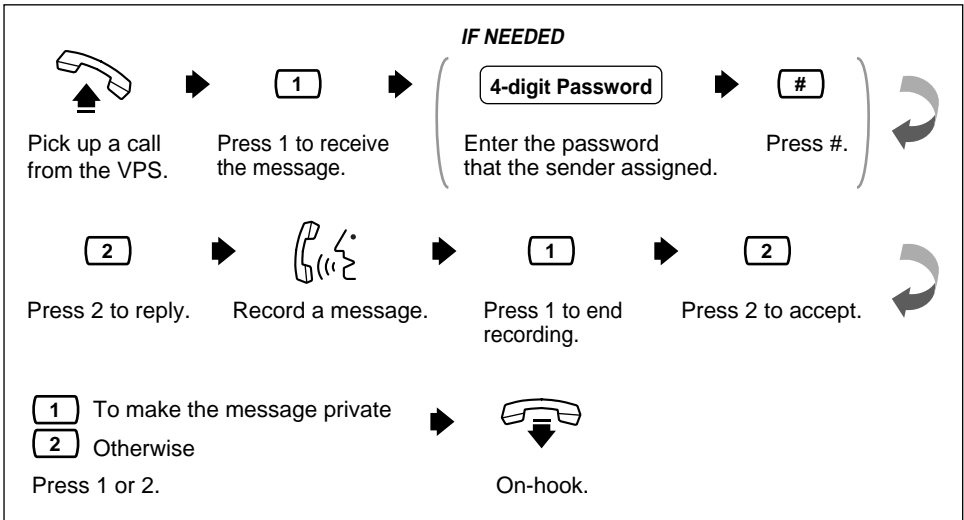

Checking and Setting External Message Delivery Status 3.7

After recording external delivery messages, you can check the delivery schedule or review the specified recipients. You can only listen to this report if the messages have not yet been delivered. After listening, you have the option of deleting messages or changing schedules.



- The System Administrator or the System Manager must authorize this feature before it can be used.

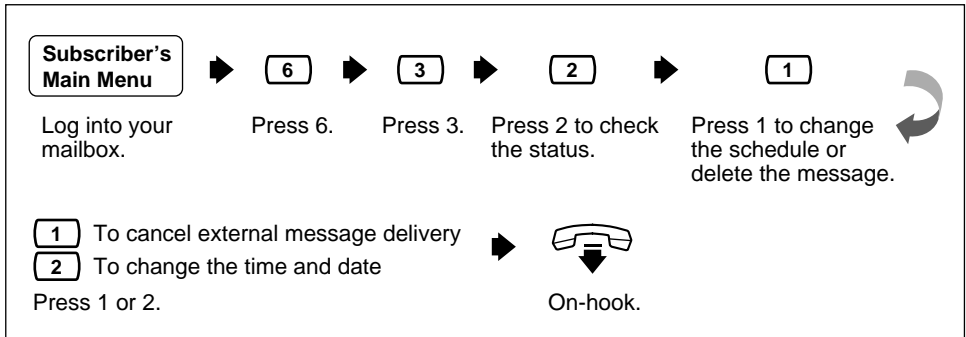

4.1 Call Transfer Status

This feature is used to specify how the VPS should handle a call when a caller reaches your extension. The following options are available: Call Blocking, Call Screening, Intercom Paging, Calling a Beeper, or Disable All Transfer Services.

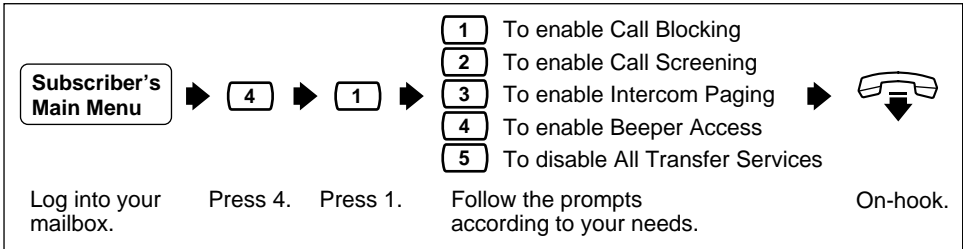

- The Intercom Paging feature is available only if you are using a Panasonic KX-TA624 or KX-TD series telephone system.

4.2 Covering Extension

The caller goes to the covering extension in 2 ways. One way is via the Automated Attendant Service when the Incomplete Call Handling Status has enabled Covering Extension Transfer Status (see 4.3 Incomplete Call Handling Status). The second way is during a Personal Greeting announcement — if the caller presses [0] while a Personal Greeting is played, he is sent to the covering extension, or an operator (if the covering extension is not specified).

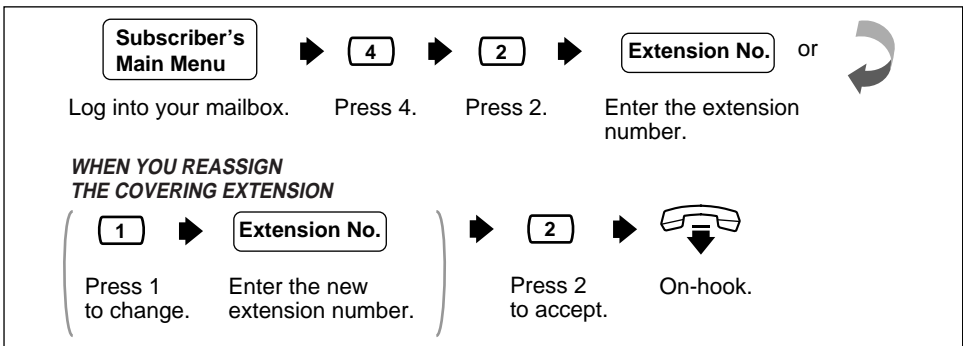

- The caller will not know to press [0] for transfer to your covering extension. Therefore, the caller must be instructed. For example, you might record the Busy greeting in this way: "Hi, this is Cindy. Sorry, but I am busy with another call right now. If you press [0] now, you will be transferred to my secretary. Otherwise, please leave a message after you hear the tone."

Incomplete Call Handling Status 4.3

Calls are considered incomplete if there is no answer or if the line is busy. The Incomplete Call Handling Status has 6 options: (1) record a message from the caller; (2) transfer the caller to a covering extension; (3) page the mailbox owner by intercom (Intercom Paging); (4) notify the mailbox owner via a beeper; (5) transfer the caller to the operator; or (6) let the caller try another extension.

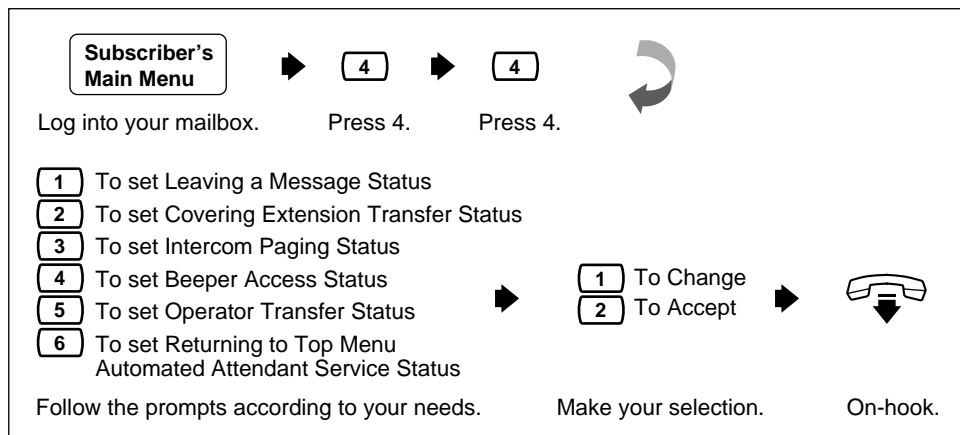

- The Intercom Paging feature is available only if you are using a Panasonic KX-TA624 or KX-TD series telephone system.

Message Reception Mode 4.4

This feature is used to direct callers to either your regular or interview mailbox. This mode is effective only for Incomplete Call Handling Service (when the subscriber's line is busy, or he cannot take the call, or when he has enabled Call Blocking).

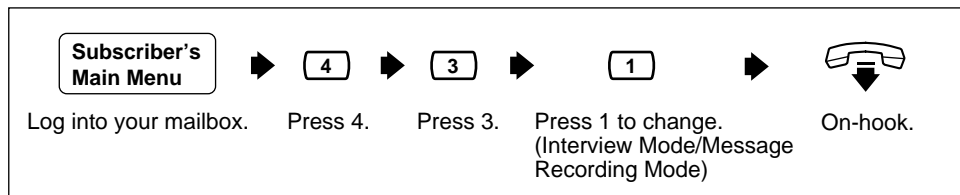

- Not all subscribers have an interview mailbox. The System Administrator or the System Manager must assign an interview mailbox.

4.5 Personal Group Distribution Lists

A Personal Group Distribution List is used to send the same message to several mailboxes in a single operation. Up to four lists can be maintained with each list containing up to twenty mailbox members.

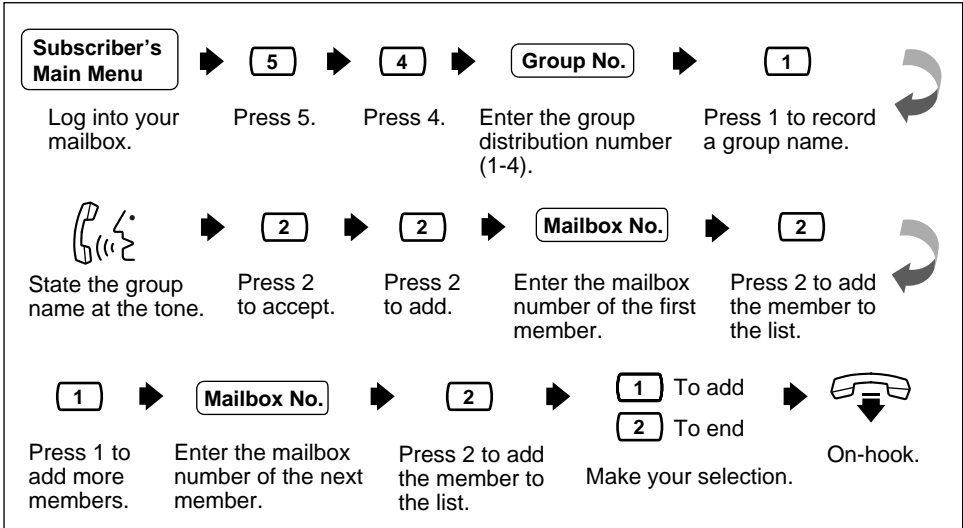

4.6 Deleting Group Distribution Members

This feature is used to delete group members from a Group Distribution List. Members can be deleted individually or they can all be deleted at the same time.

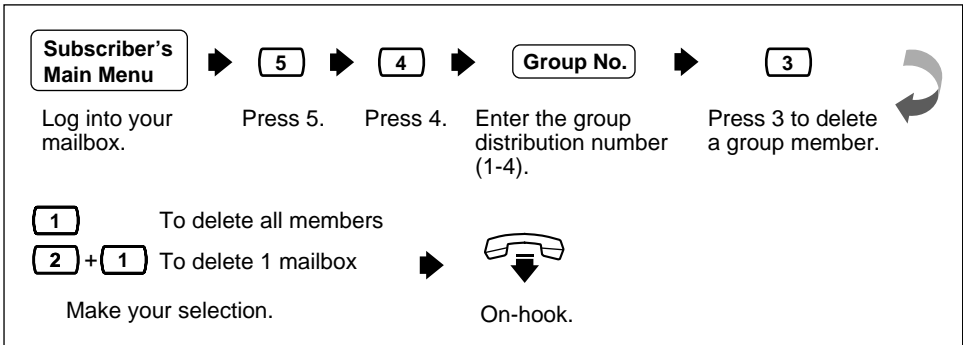

Deleting Group Distribution List Names 4.7

This feature is used to delete a group distribution list name.

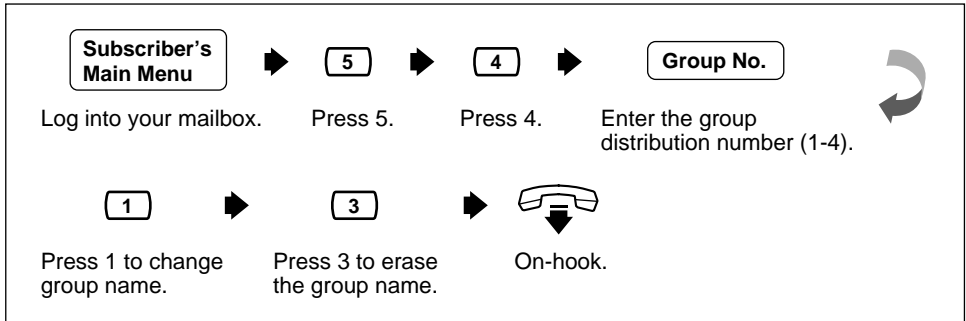

Message Waiting Notification 4.8

The VPS is able to notify you when a new message has been recorded in your mailbox. You can be notified (1) by Message Waiting Lamp on your proprietary telephone, or (2) by a call to another telephone (e.g., your mobile phone), or (3) by your beeper. You can assign time frames to each of these devices. The VPS is also able to notify your beeper with the callback number of the party who left the message. The telephone number stored on the VPS for your beeper must include the beeper display command.

Three features can be set for message waiting notification: Message Waiting Lamp Status, Change Device Status, and Assign Telephone Number. These features can be set by the System Administrator or at a subscriber telephone. Each device has its own phone number that must be entered.



- The System Administrator or the System Manager must authorize this feature before it can be used.
- **Message Waiting Lamp Notification Setting**
The VPS illuminates the message waiting lamp of your extension when a new message is recorded in your mailbox.
- **Setting Device Status**
For each device, the notification can be continuous, disabled, or enabled to a preset schedule. Setting notification to a preset schedule can only be established by the System Administrator.
- **Notification Number Assignment**
You can set up to 3 telephone or beeper numbers to ring when you wish to receive notification calls.

4.8 Message Waiting Notification (contd.)

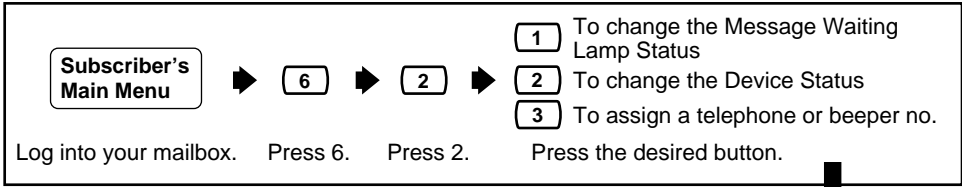

WHEN YOU PRESS 1

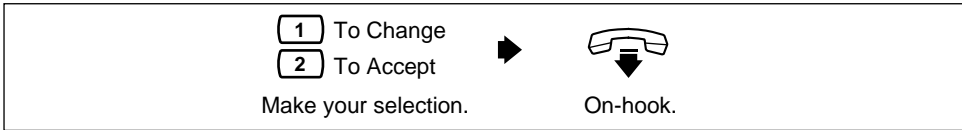

WHEN YOU PRESS 2

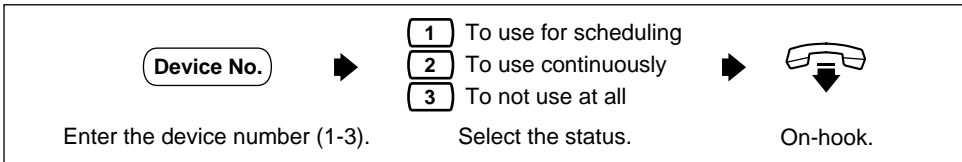

WHEN YOU PRESS 3

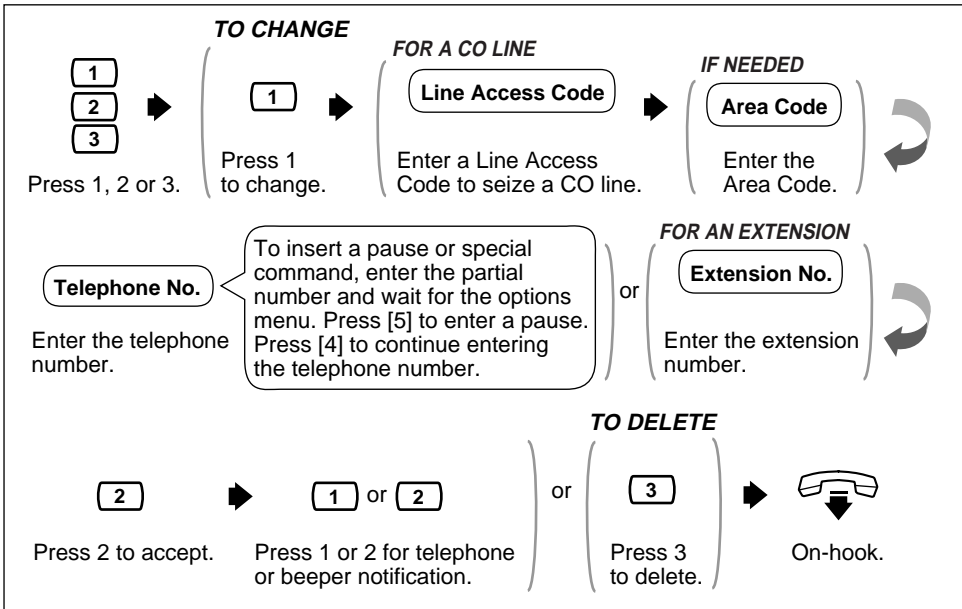

• If you do not know your line access code, ask your System Manager.

An Interview Mailbox plays pre-recorded questions to callers and records their answers. You can record up to 10 questions and set the answer lengths from 4 to 32 s. The answers are recorded and stored, in order, in your mailbox. The answer length must be set and questions must be recorded.



- To activate this feature your System Manager or System Administrator must assign an Interview Mailbox to your mailbox.

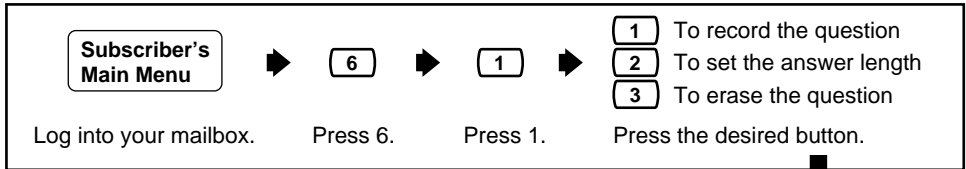

WHEN YOU PRESS 1

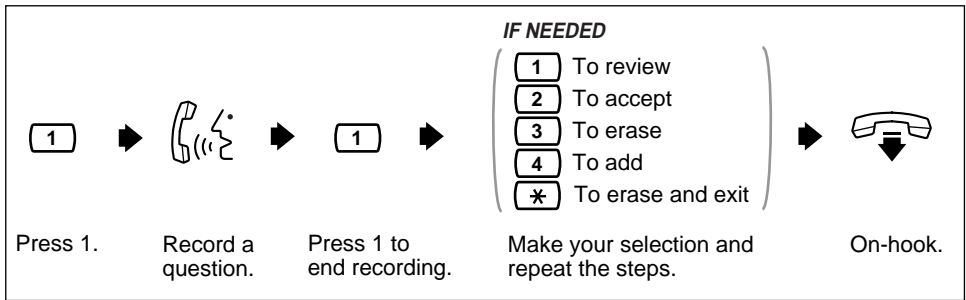

WHEN YOU PRESS 2

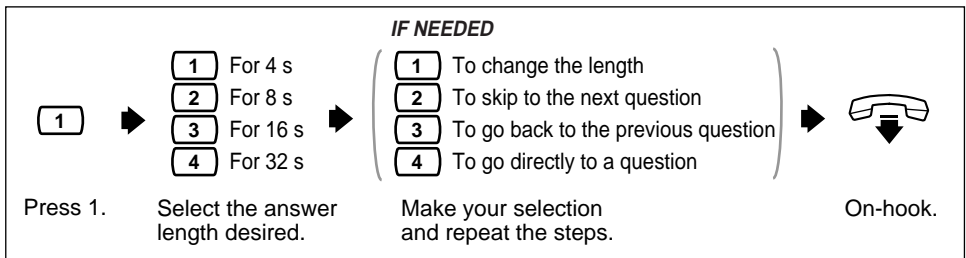

WHEN YOU PRESS 3

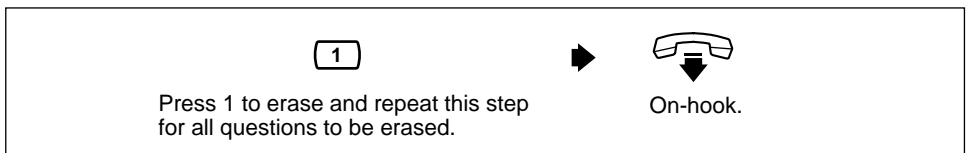

4.10 Recording Personal Greetings for Caller ID

This feature allows you to record up to 4 personal greetings for calls from assigned Caller ID numbers. Each personal greeting supports up to 8 Caller ID numbers. To enable this feature, first record a greeting, then assign Caller ID numbers. To assign Caller ID numbers, see 4.11 Assigning Caller ID Numbers for Personal Greeting for Caller ID.



- This feature is available to you only if you are using a Panasonic KX-TA624 or KX-TD series telephone system.
- If you cannot use this feature, ask your System Administrator or System Manager. He might have disabled it.

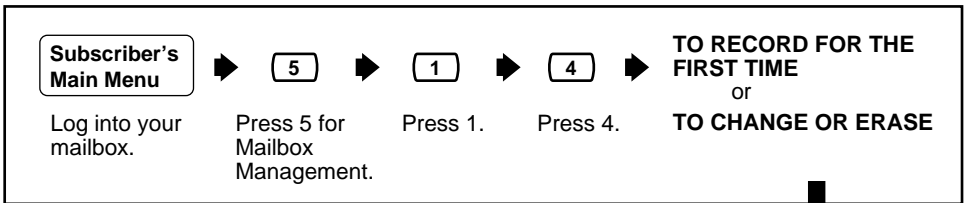

TO RECORD FOR THE FIRST TIME

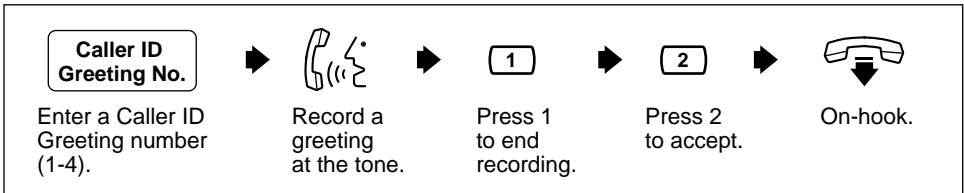

- You can go on to assign Caller ID numbers after accepting the recorded greeting.

TO CHANGE OR ERASE

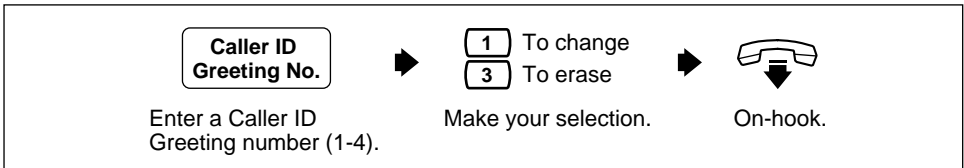

- When you change the greeting, follow the steps in “TO RECORD FOR THE FIRST TIME” to re-record.

Assigning Caller ID Numbers for Personal Greeting for Caller ID 4.11

This feature is used to assign Caller ID numbers for pre-recorded personal greetings. Each greeting supports up to 8 Caller ID numbers.



- To assign Caller ID numbers, first record a personal greeting. (See 4.10 Recording Personal Greetings for Caller ID.)

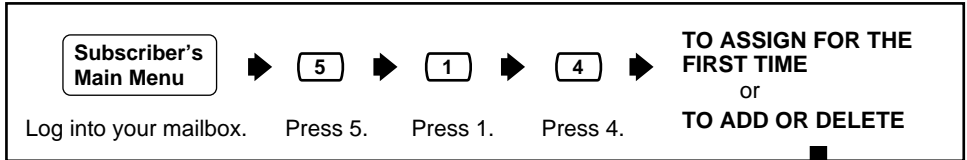

TO ASSIGN FOR THE FIRST TIME

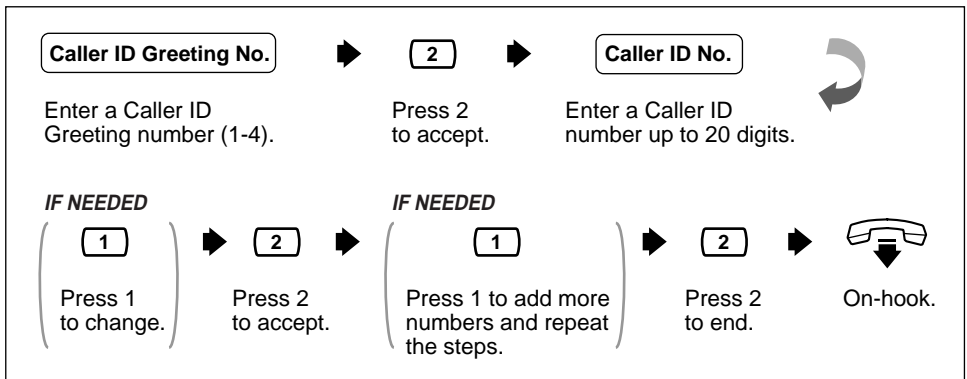

- For the caller ID Number, you can use “*” as a wild card. For example, if you assign “021 (area code) * * * * *”, calls from area code “021” will hear the same greeting.
- If you enter a number which you have already assigned, the prompt notifies you. Follow the prompt and enter another number.

4.11 Assigning Caller ID Numbers for Personal Greeting for Caller ID (contd.)

TO ADD OR DELETE

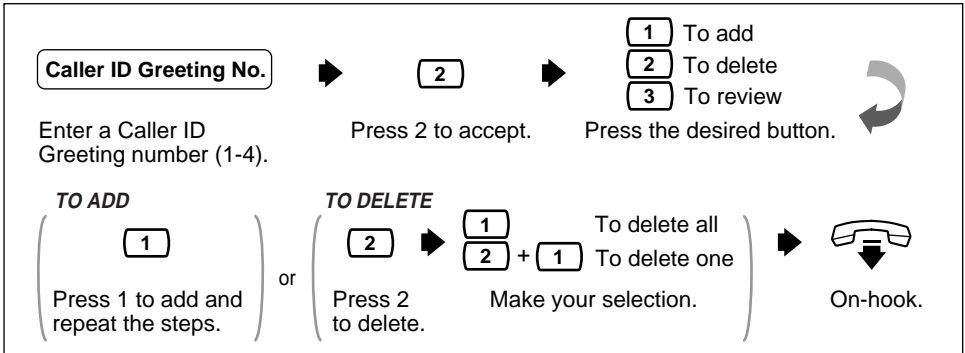

- When you add a Caller ID number, follow the steps in “TO ASSIGN FOR THE FIRST TIME” to assign.

4.12 Personal Caller Name Announcement

This feature allows you to assign up to 30 Caller ID numbers and record a caller name for each Caller ID number from your telephone. The caller name is announced when you listen to the messages from assigned numbers left in your mailbox. It is also announced when calls from assigned numbers are transferred from the VPS to you (Caller ID Screening).



- This feature is available to you only if you are using a Panasonic KX-TA624 or KX-TD series telephone system.
- The System Administrator or the System Manager can change the maximum number of Caller IDs for the Personal Caller Name Announcement for each Class of Service.
- If Caller ID Screening does not work, consult your System Administrator or System Manager. He might have disabled it.

Personal Caller Name Announcement (contd.) 4.12

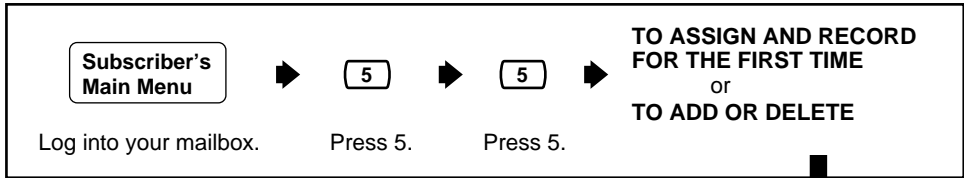

- To change an assigned Caller ID number and/or caller name, first delete them and then add new ones.

TO ASSIGN AND RECORD FOR THE FIRST TIME

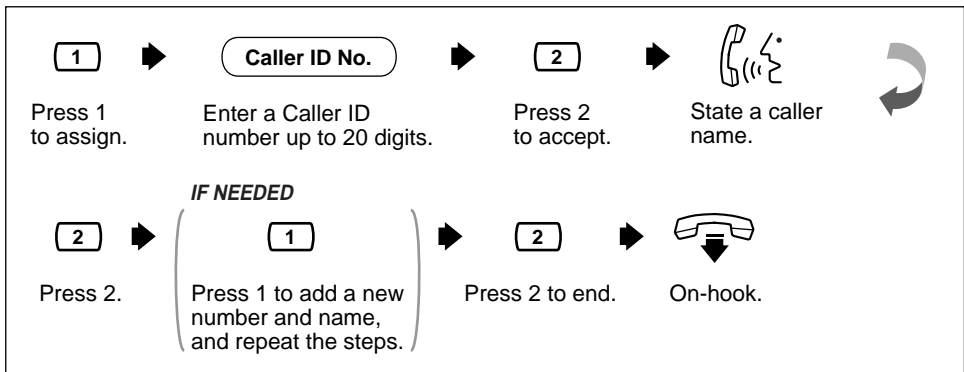

- If you enter a number which you have already assigned, the prompt notifies you. Follow the prompt and enter another number.

TO ADD OR DELETE

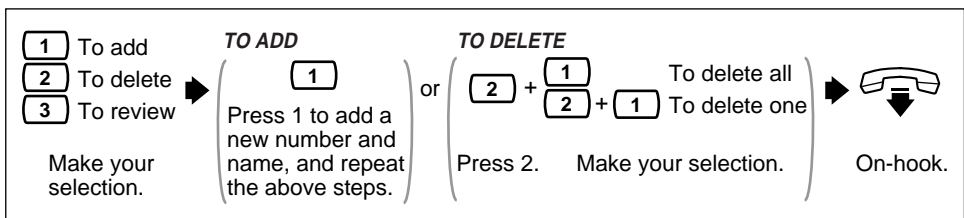

4.13 Live Call Screening

By assigning one of your telephone keys to this feature, you can monitor incoming calls that have been forwarded to the Voice Mail Service.

When in the Hands-Free Mode, you can monitor the incoming call through the telephone's built-in speaker. You can speak with the caller by picking up the handset.

When in the Private Mode, you can monitor the incoming call through the handset after you hear the notification tone. You can speak with the caller by pressing the feature key or you can stop listening to the message by replacing the handset.



- This feature is available to you only if you are using a Panasonic KX-TA624 or KX-TD series telephone system and if the System Administrator has provided your extension with this feature.
- For detailed information concerning this feature, please refer to the Installation Manual for the Panasonic KX-TA624 or KX-TD series telephone system.

4.14 Recording a Two-Way Conversation

By assigning one of the function keys on your telephone to this feature, you can record the conversation that you are having.

You must always notify the other party before you begin recording.



- This feature is available to you only if you are using a Panasonic KX-TA624 or KX-TD series telephone system.

Quick Reference

To Enter a Mailbox
From a Remote
Location, Dial:
#6*+ mailbox number

Password #

Main Menu:
You have *** new
messages.

1 Receive message.
2 Deliver message.
3 Check Mailbox
Distribution.
4 Set Automated
Attendant (AA)
Status.
5 Set Up Mailbox
Management.
6 Set Other Features.
* Hang up.

Receive Message:
1 Repeat Message
1.1 Previous Message
2 Next Message
3 Erase Message
4 Send Reply
5 Rewind
6 Fast Forward
7 Transfer Message
8 Scan Messages
0 Help

**Deliver Message:
Enter Mailbox Number**
1 Record Message
2 Add Another Mailbox
3 Review Mailing List

Check Mailbox Distribution
1 Play Message
1.1 Check Previous Message
2 Check Next Message
3 Cancel

Set AA Status:
1 Set Call Transfer Status
2 Set Covering Extensions
3 Set Message Reception Mode
4 Set Incomplete Call Handling

Set Up Mailbox Management:
1 Record Personal Greetings
2 Set Password
3 Enter Owner's Name
4 Set Group Distribution List
5 Record Caller Name

Set Other Features:
1 Set Interview Mailbox
2 Set Message Waiting Notification
3 Set External Delivery Message

Set Call Transfer Status:
1 Call Blocking
2 Call Screening
3 Intercom Paging
4 Beeper Access
5 All Disable

Incomplete Handling Status
1 Leaving a Message
2 Covering Extension
3 Intercom Paging
4 Beeper Access
5 Operator
6 Return to AA Service Top Menu

Record Personal Greeting
1 No Answer
2 Busy
3 After Hours
4 Caller ID

Interview Mailbox Management
1 Record Question
2 Set Answer Length
3 Erase Question

Message Notification
1 Message Waiting Lamp
2 Device Status
3 Assign Telephone Numbers

External Message Delivery
1 Record message
2 Check Delivery Status
3 Set a Mailing List

Service Access Commands
Dial the following commands any time during system prompts to get a different mailbox, extension, or menu.

1	#1 Dial by Name	2	#3 (#D) Department Dial
4	#5 (#L) Login	5	#6 (#M) Voice Mail
7	#7 (#R) Restart (Main Menu)	8	#8 (#T) Transfer to an Extn.
9	#9 (#X) Exit	0	0 Help
*	Return to Previous Menu	#	

Glossary

Alternate Extension Group

Transfers the call coming into the extensions in this group following the sequence specified by "Alternate Extension Transfer Sequence".

APT Integration

Digital Integration between the KX-TA624 and the VPS.

Auto Configuration

(Available with APT/DPT Integration only.) The VPS can automatically draw information from the KX-TA624, the KX-TD816, the KX-TD1232 or the KX-TD308. This saves time in the initial setup.

Auto Forwarding

Allows unretrieved messages to be copied or forwarded to another mailbox.

Automated Attendant

An electronic operator capable of transferring a caller to an extension.

Call Blocking

Connects the caller to the Incomplete Call Handling Service without ringing the subscriber's extension.

Call Screening

Allows subscribers to screen calls; the caller hears the message: "Record your name at the tone." The VPS records the caller's name, then puts the caller on hold to play the name for the subscriber who decides whether to take the call or not.

Call Transfer

Transfers a call to the requested destination or to an alternative extension.

Called Party ID

(Sometimes referred to as Follow-On ID) Allows the VPS to dial extra digits to bring the caller directly to a specified mailbox, rather than to the General Delivery Mailbox.

Caller ID Call Routing

(Available with APT/DPT Integration only.) The VPS automatically sends calls from pre-assigned Caller ID numbers to the desired extension, mailbox (System Group Distribution List included) or Custom Service.

Caller Name Announcement (System/Personal)

(Available with APT/DPT Integration only.) The VPS announces pre-recorded Caller ID caller's names when extension users listen to messages from pre-assigned numbers left in the user's mailbox. The announcement is also heard when calls from pre-assigned numbers are transferred to the users (Caller ID Screening).

Covering Extension

This can be a destination for Incomplete Call Handling Service. Also, it can be accessed by pressing [0] during the playing of a Personal Greeting.

Custom Service Setting

Allows one-touch access to extensions, other custom service menus, fax machine, mailboxes, etc. A greeting can be recorded for each of the 100 menus to give verbal directions to the non-subscriber.

Default Setting

A parameter, which was defined for the system at the factory and can be changed through system programming; i.e. the System Administrator.

Delayed Ringing

There are 2 kinds of delayed ringing applications:

- (1) The VPS is used as the no-answer destination for the Intercept Routing feature of your PBX.
- (2) DIL 1:N (CO line to several extensions) terminates on telephones and VPS ports. To give the telephone users a chance to answer calls, the VPS lines should be programmed for delayed ringing. Otherwise, the VPS will answer the calls immediately.

Delivery Time

The time specified by the subscriber for the VPS to deliver a pre-recorded message.

Department Dialing

A number (1–9) assigned to transfer an outside caller to a specific extension.

Direct Mailbox Access

(Available with APT/DPT Integration only.) A subscriber can enter his mailbox directly when he calls the VPS from his extension. He does not have to enter any special codes. But his password, if established, must be entered.

DPT Integration

Digital integration between the KX-TD816, the KX-TD1232 or the KX-TD308 and the VPS. Requires upgraded software in the telephone switch.

DTMF

(Dual Tone Multi Frequency) Commonly referred to as touch-tone.

External Call Forwarding

(Available on the KX-TA624, the KX-TD816, the KX-TD1232 and the KX-TD308) Forwards calls to an extension that has call forwarding activated to an outside phone.

External Delivery Message

A message intended for automatic delivery to outside parties and/or extensions.

External Message Delivery List

Allows the subscriber to create 2 lists to deliver messages to outside parties. Each list can have 8 destinations.

External Message Delivery Redial

Allows the subscriber, when making an external delivery, to instruct the VPS to make a maximum of 9 retries when the line is busy or when there is no answer.

Fast Forward

Puts the user 4 s ahead in the current message.

Follow-On ID

See Called Party ID.

General Delivery Mailbox

When the caller does not dial anything (either because he does not want to or he is using a rotary telephone), he can be sent to the General Delivery Mailbox. Periodically (daily is best), the Message Manager should transfer the contents of the General Delivery Mailbox to the appropriate destinations.

Hash Sign

Same as Pound Sign. Hash Sign is used only in the United Kingdom.

HELP

One of the utility commands. It lists all utility commands with a brief description of each.

Immediate Reply

Allows the message receiver to reply to a message without specifying the extension number of the sender.

Inband Signaling

The Follow-On ID (or Called Party ID) that integrates the VPS and the telephone switch. Uses intercom paths to light message wait light. Does not give "high end" features such as: Intercom Paging, Direct Mailbox Access, Live Call Screening, etc.

Incomplete Call Handling Service

Calls are considered incomplete when there is no answer or if the line is busy. The Incomplete Call Handling Service can be set for 6 options:

- (1) to record a message from the caller,
- (2) transfer the caller to a covering extension,
- (3) page the mailbox owner via the PBX,
- (4) notify the mailbox owner via beeper,
- (5) transfer the caller to the operator, or
- (6) let the caller try another extension.

Integration

Required between the VPS and the telephone switch. See Inband signaling, APT Integration and DPT Integration.

Intercept Routing No Answer

When a call is not answered, it can be transferred to another extension, or to the VPS. (This is a PBX feature.)

Intercom Paging

(Available with APT/DPT Integration only.) Allows up to 8 different paging groups. An outside party can reach a subscriber who is away from his/her telephone using either internal or external page groups. For a Caller ID caller, if his name has been recorded for the Caller Name Announcement feature, the name will be announced at the end of the page.

Interview Service

A special type of subscriber mailbox enabling the subscriber to record up to 10 questions. After the answers are recorded the Message Waiting Lamp is turned on at the subscriber telephone. (Good for claims departments, order desks, job applications, etc.)

Keypad

All touch-tone keys on the telephone.

LCD

Liquid crystal display

Live Call Screening

(Available with APT/DPT Integration only.) The proprietary telephone works like an answering machine. The subscriber can hear the caller through the speakerphone while the message is being recorded.

LOAD

One of the utility commands. It is used to load new or saved data to the VPS from a personal computer.

Logical Extension (All Calls Transfer to Mailbox)

An extension that always receives calls directly into its mailbox. This feature is used by subscribers who are often unavailable or who do not have a telephone.

Mailbox Capacity (messages)

The number of messages that can be recorded in a subscriber's mailbox; should be set between 5 and 100 messages by the System Administrator or the System Manager.

Mailbox Capacity (recording time)

The total amount of time for messages in a subscriber's mailbox; should be set between 5 and 100 min by the System Administrator or the System Manager.

Mailbox Extension

Normally the same number as the telephone extension number.

Mailbox Management

Allows a subscriber to alter the setting for personal mailboxes.

Menu

A list of choices from which the user can select by using the telephone keypad or the keys from a personal computer.

Message Manager

(Mailbox 998) The person who takes care of the general delivery messages, records custom service menus and system caller names, and changes the original voice prompts. He has limited system programming capabilities.

Message Retention Time

The amount of time the system will store a message before deleting the message.

Message Retrieval Order

The order in which the subscriber retrieves messages: Last In First Out (LIFO) or First In First Out (FIFO).

Message Transfer

Allows a subscriber to reroute a message to another mailbox unless the message was marked "private." Additional comments can be added to this message.

Message Waiting Lamp

Light on proprietary telephones that lights when there are messages in the mailbox.

Message Waiting Notification

The VPS can notify subscribers and the Message Manager when they have received messages (if authorized by the System Administrator or the System Manager). Notification methods are: (1) by Message Waiting Lamp, or (2) by telephone, or (3) by beeper.

Multilingual Selection Menu

This menu is recorded by the Message Manager and allows callers to choose the language they want (System, User 1 or User 2 prompts) when they call the VPS.

Non-Subscriber

A caller to the VPS who does not own a mailbox.

Notification Method

(See Message Waiting Notification.)

Operator

Up to 3 destinations can be assigned as operators. This is the extension that receives calls when the calling party is on a rotary phone or dials [0].

Owner's Name

After a subscriber records his name, his name will be announced during transfers, Intercom Paging, and confirmation of Dialing by Name. Independent of this recording is registration of name by System Administrator. This allows callers to dial parties by name (Dialing by Name) rather than by number. For example, a caller can dial "S-M-I-T" (Smith) rather than Smith's mailbox number, which can be hard to remember.

Password

A number chosen by a subscriber or a manager to protect access to the mailbox.

Personal Greetings

A subscriber can personalize his mailbox to greet callers. There are 3 kinds of Personal Greetings:

- (1) No Answer Greeting
- (2) Busy Signal Greeting
- (3) After Hours Greeting

Personal Greeting for Caller ID

(Available with APT/DPT Integration only.) Each subscriber can record up to 4 personal greeting messages for calls from pre-assigned Caller ID numbers. Each greeting supports up to 8 Caller ID numbers.

Personal Group Distribution List

Each subscriber can have 4 distribution lists containing up to 20 mailboxes in each list. Used to send the same message to a variety of people.

Port

The point of connection between the telephone switch and the VPS.

Pound Sign

The [#] key on the telephone keypad.

Private Message

A message, which is delivered to a specific mailbox, cannot be forwarded.

Prompt

A pre-recorded list of options or a guidance message played to the user. The English system prompts are pre-recorded at the factory and cannot be changed. Up to 2 other languages can be recorded as user prompts.

Review

Plays back a message.

Rewind

Replays the last 4 s of a message.

Rotary Telephone

A telephone capable of pulse dial only. Callers using a rotary telephone will be automatically forwarded to the operator or the General Delivery Mailbox.

SAVE

One of the utility commands. It is used to save VPS data to a personal computer.

Scanning Messages

Allows the subscriber to listen to only the first 4 s of each message. Another method is to use the digit [2] while listening to a message; this advises the VPS to skip to the next message.

Station Programming

Programming via the proprietary telephone.

Subscriber

A person who has an assigned mailbox.

System Administration

System programming from a personal computer.

System Administrator

Unlike the Message Manager and the System Manager, the System Administrator has full system programming capability. He uses a computer connected to the RS-232C port of the VPS.

System External Message Delivery Duration Time

The maximum time allowed for an external message that is to be delivered by the VPS, specified by the System Administrator.

System Group Distribution List

The system can maintain an internal list of twenty mailbox groups. Each group can hold twenty mailboxes. Each group is referenced by a System Group Distribution List number and is assigned via system administration.

A recording into a System Group Distribution List number will go into the mailboxes of all members of that group.

System Manager

(Mailbox 999) The person who can perform very basic and limited system programming using a telephone. He can create/delete mailboxes; clear subscriber passwords when they are forgotten; set Class of Service parameters; set the system clock; and generate System Reports.

System Report

Eight System Reports can be acquired by the System Administrator or System Manager upon request.

TIME

One of the utility commands. It is used to confirm or set the time and date of the VPS.

Two-Way Recording (TWR)

(Available with APT/DPT Integration only.) Allows a subscriber to record a conversation into his/her mailbox.

Two-Way Transfer (TWT)

(Available with APT/DPT Integration only.) Allows a subscriber to record a conversation into another person's mailbox.

Voice Mail

A general term used for messages recorded over the phone from one person to another.

Voice Prompt

Recorded VPS instructions to callers. These are either system prompts or user prompts.

VPS

Voice Processing System (e.g., Panasonic KX-TVS50).

**Panasonic Consumer
Electronics Company,
Division of Matsushita
Electric Corporation of
America**

One Panasonic Way, Secaucus,
New Jersey 07094

**Panasonic Sales Company
("PSC") Division of
Matsushita Electric of
Puerto Rico, Inc.**

Ave. 65 de Infantería, Km. 9.5,
San Gabriel Industrial Park, Carolina,
Puerto Rico 00985

Copyright:

This manual is copyrighted by Kyushu Matsushita Electric Co., Ltd. (KME).
Under the applicable copyright laws, this manual may not be reproduced in any
form, in whole or part, without the prior written consent of KME and its licensee.

© 2000 Kyushu Matsushita Electric Co., Ltd. All Rights Reserved.